

NICE100+ Series

Open loop integrated elevator control solution

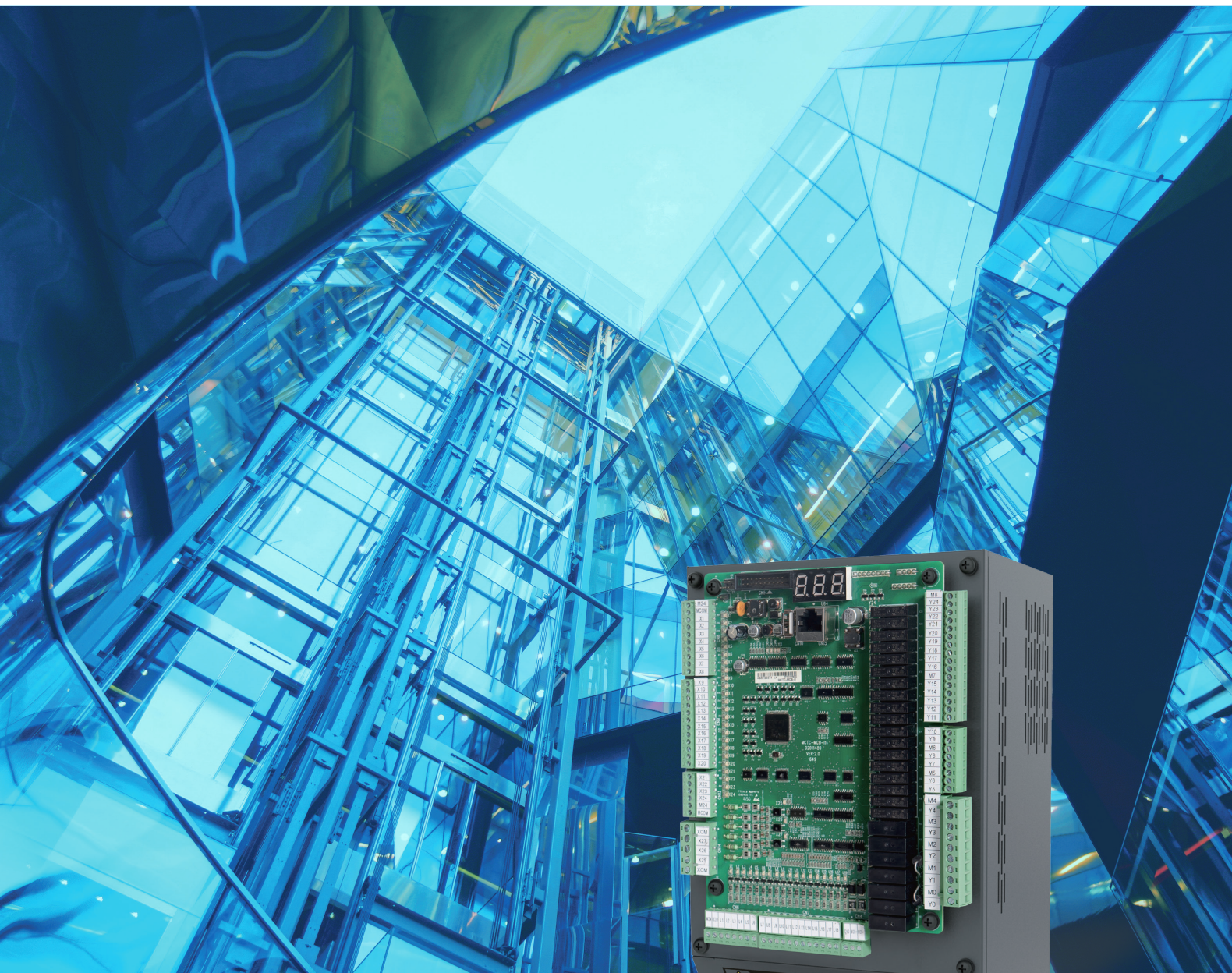

Open loop integrated solution for elevators ≤ 1.00 m/sec

Controller Features

- Supports 6 floor collective, expansion option up to 12 floors
- Selectable door control mode (automatic, manual, semi-automatic)
- Flexible & programmable I/O's
- Robust on-board relay for outputs
- Comprehensive trip diagnostics
- Supports double digit 7 segments, Binary, Grey codes display functions
- Built-in automatic rescue operation feature

Enhanced reliability with conformal coating, protects against humidity and dust pollution

Operation in high ambient temperatures  $45^{\circ}\text{C}_{\text{avg}}$

Wide operating voltage range 323 to 528 Vac

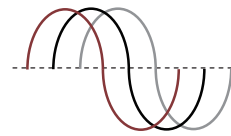

Conventional parallel wiring:
12 floors full collective



6 floors, full collective
(standard base unit)

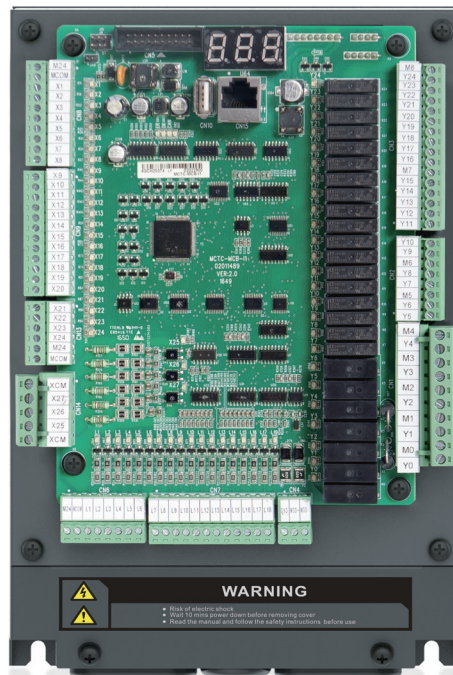

*¹ Apps & *² PC-Tools software offer simplified start up, diagnosis & backup



*¹ available soon

*² compatible with Windows 7/10

Double digits
7 segment display

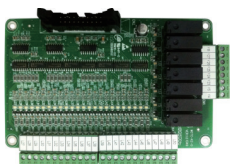

12 floors, full collective
with expansion I/O's
(MCTC-KZ-D)



Inverter Features

- Supports open loop asynchronous geared machine
- Smooth ride performance
- Integrated brake and motor output contactors control with monitoring
- Quick and Easy setup with factory default settings
- 6-Independent S-Ramps
- Better levelling accuracy
- 220Vac UPS supported rescue operation with Light load direction sensing

General Connection Diagram

Standard 6 floors full collective, expansion 12 floors full collective

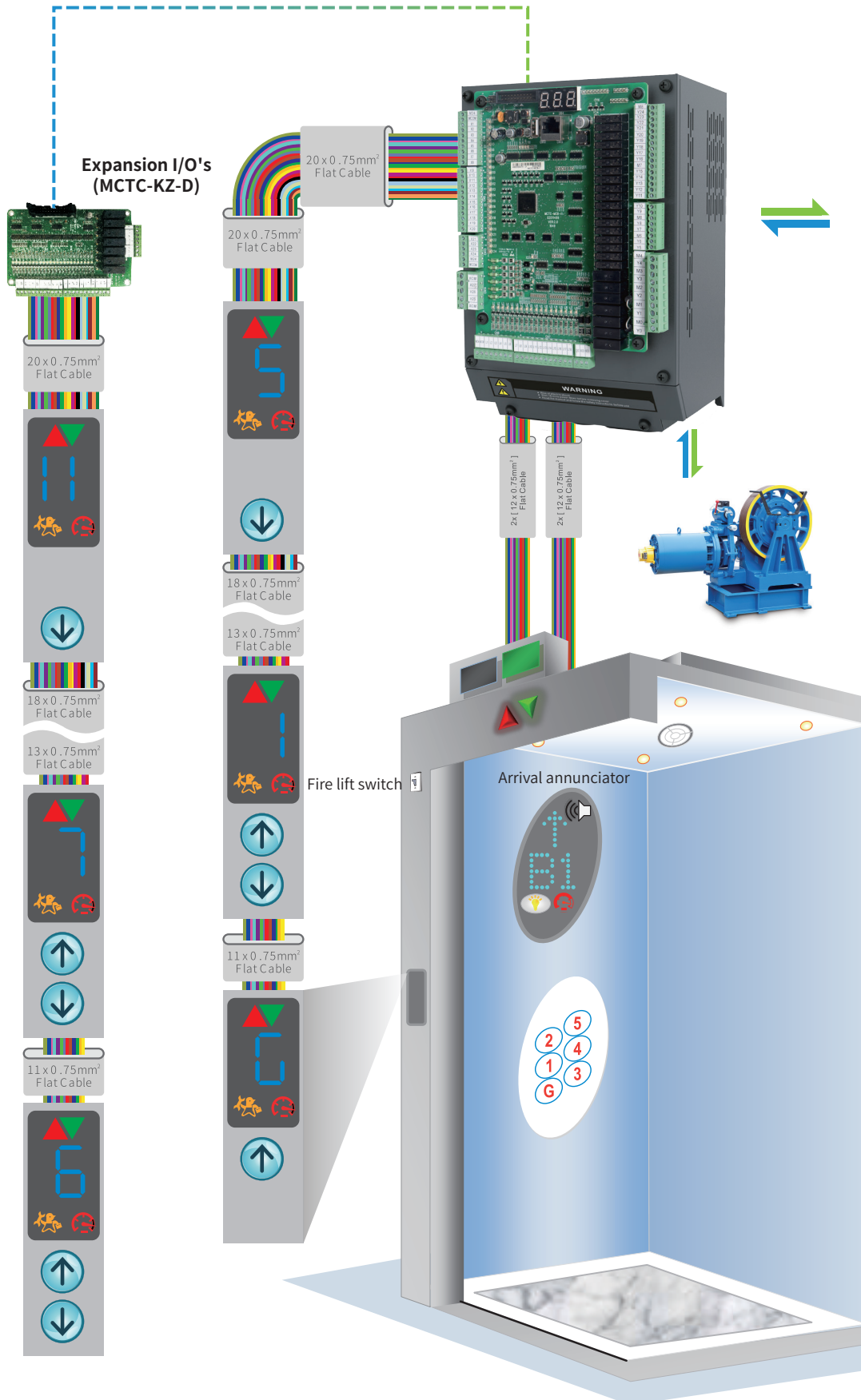

Optional: hot pluggable LED/LCD remote keypad

NEW



***3 MDKE9**

Multilingual keypad with memory.
Languages include:
English, Turkish, Italian and Russian

NEW



MDKE6

With memory for
parameter upload/download



MDKE

Without memory

*3 available soon

Product Code



MODEL: NICE-L-I-4003
 INPUT: 3PH AC 380-480 V 10.5A 50/60 Hz
 OUTPUT: 3PH AC 0-440 V 9A 0-90 Hz 3.7 kW
 Serial No.: 010302314K200112



Suzhou Inovance Technology Co., Ltd.

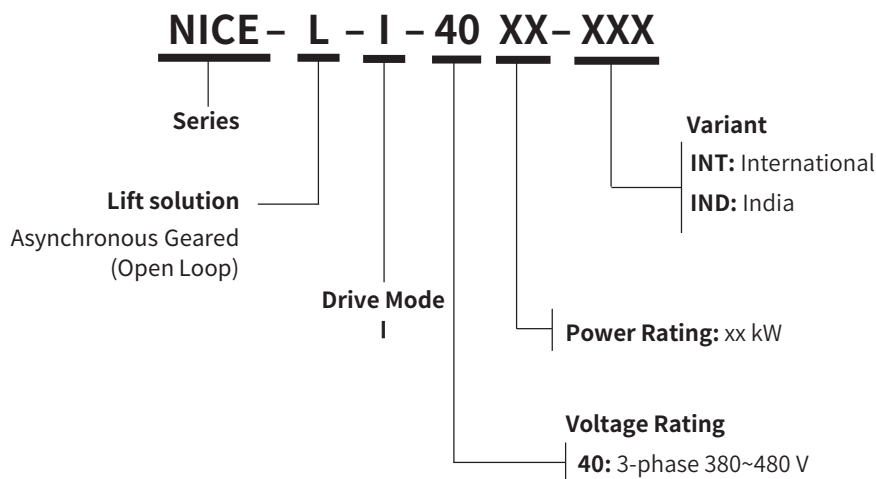

General Specifications

380 to 480 Vac, -15% to +10% (323 to 528 Vac)

Model	Frame Size	Input Power [kVA]	Input Current [A]	*4 Output Current [A]	Typical Motor [KW]	Dynamic Braking Unit	Dynamic Braking Resistor		
							Min [Ω]	Max [Ω]	Recommended Power [W]
NICE-L-I-4003-XXX	C	5.9	10.5	9	3.7	Built-in	135	170	≥ 1,100
NICE-L-I-4005-XXX		8.9	14.8	13	5.5		90	115	≥ 1,600
NICE-L-I-4007-XXX	D	11	20.5	18	7.5		65	85	≥ 2,500
NICE-L-I-4011-XXX		17	29	27	11		43	55	≥ 3,500
NICE-L-I-4015-XXX		21	36	33	15		35	43	≥ 4,500

*4 Carrier switching frequency 6 kHz at rated output current @150% overload for 60 sec and @200% for 2 sec

Please note: all units have IP20 rated enclosures and are fan cooled

Input RFI Filter & AC Line Reactor Specifications

380 to 480 Vac, -15% to +10% (323 to 528 Vac)

Model	Frame Size	Input Power [kVA]	Input Current [A]	Input RFI Filter Model		Input AC Line Reactor
				Changzhou Jianli	Schaffner	Inovance
NICE-L-I-4003-XXX	C	5.9	10.5	DL-16EBK5	FN 3258-16-33	MD-ACL-10-1.4-4T-2%
NICE-L-I-4005-XXX		8.9	14.8	DL-16EBK5	FN 3258-16-33	MD-ACL-15-0.93-4T-2%
NICE-L-I-4007-XXX	D	11.0	20.5	DL-25EBK5	FN 3258-30-33	MD-ACL-30-0.47-4T-2%
NICE-L-I-4011-XXX		17.0	29.0	DL-35EBK5	FN 3258-30-33	MD-ACL-30-0.47-4T-2%
NICE-L-I-4015-XXX		21.0	36.0	DL-50EBK5	FN 3258-42-33	MD-ACL-40-0.35-4T-2%

Dimensions

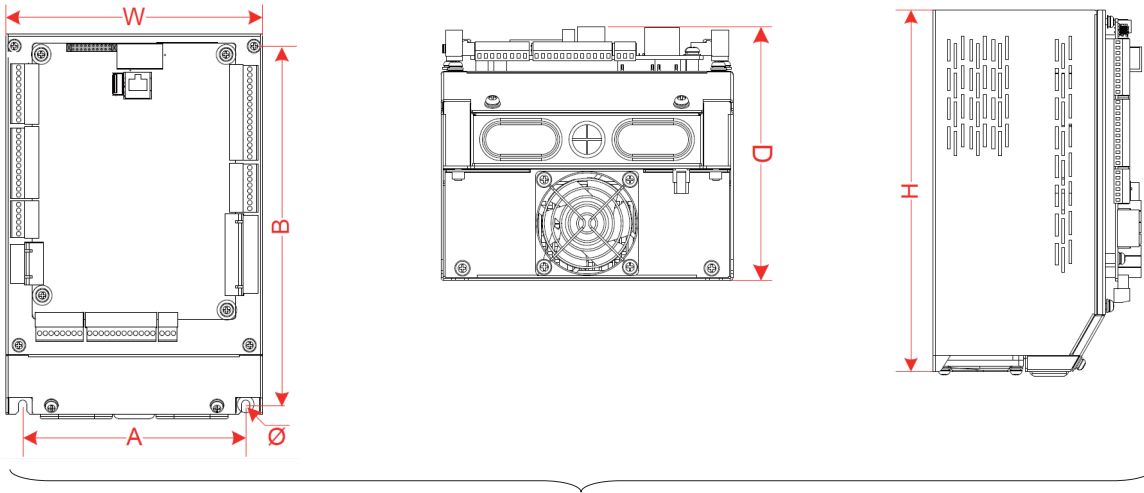

Frame size C, D

Frame Size	Dimensions (mm)					Hole Diameter (mm)
	A	B	H	W	D	
C	148	235	248	170	145	5.5
D	150	345	359	220	179	7

Design Compliance

- EMC Directive 2004/18/EC
 - EN 61800-3
 - EN 55011

- LVD Directive 2006/95/EC & 93/69/EEC
 - EN 61000-6-2
 - EN 61800-5-1

We Pioneered NICE Integrated Solutions for Elevators



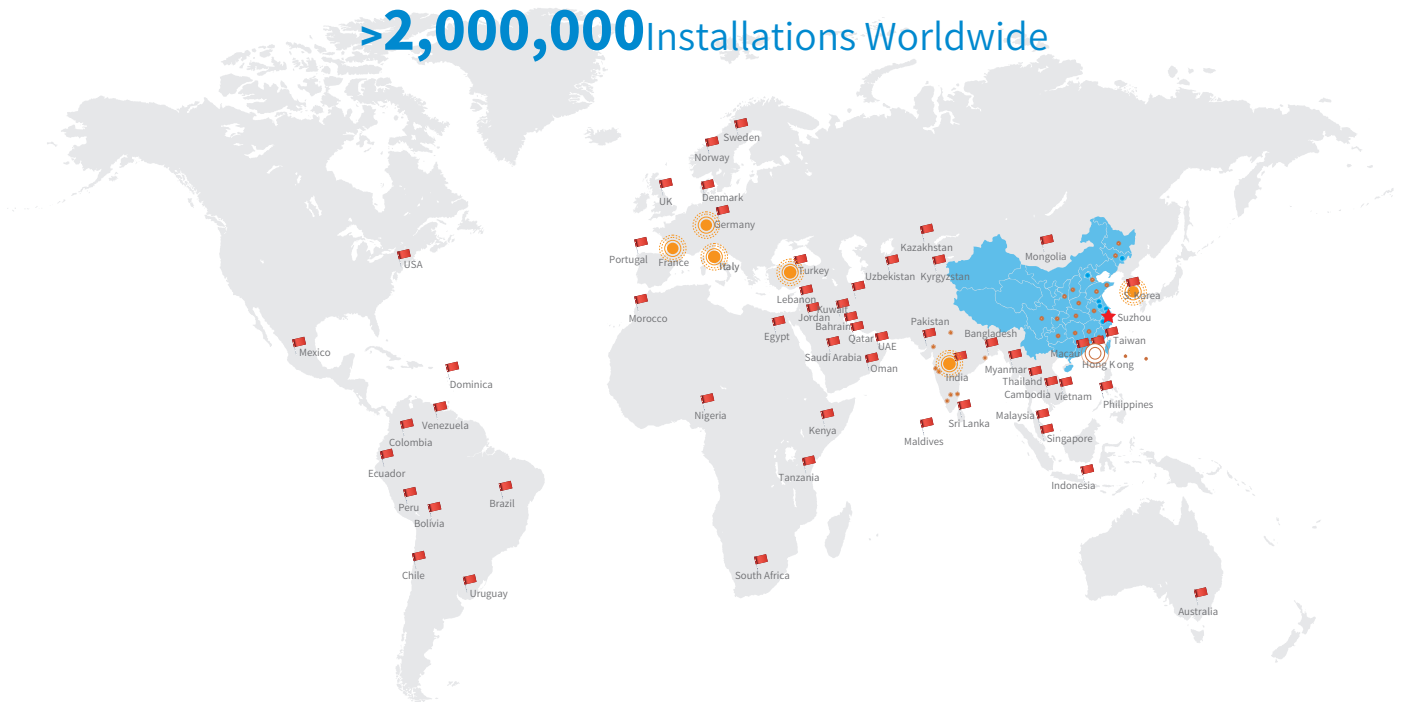

>2,000,000 Installations Worldwide



INOVANCE

www.inovance.eu

International Offices

-  **Germany-Stuttgart**
Tel: +49 (0) 7144 8990 | sales.de@inovance.eu
-  **Italy-Milano**
Tel: +39 (0) 2268 22318 | sales.it@inovance.eu
-  **France-Bordeaux**
Tel: +33 (0) 5594 01050 | sales.fr@inovance.eu
-  **Turkey-Istanbul**
Tel: +90 (216) 706 17 89 | info@inovance.eu
-  **South Korea-Seoul**
Tel: +82 (0) 10 7428 5732 | info@inovance.eu

Hong Kong SAR

International Export Office

Tel: +852 2751 6080 | info@inovance.eu

India

Head Office Chennai | Tel: +91 (0) 44 4380 0201
Ahmedabad | Tel: +91 794003 4272
Mumbai | Tel: +91 22 4971 5883
New Delhi | Tel: +91 11 4165 4524
Sales Network in Kolkata, Bengaluru, Pune, Coimbatore, Hyderabad, Vadodara, Jaipur
Email: info@inovance.ind.in

For other country distributors, contact the Hong Kong office.

Inovance Technology Companies

Shenzhen Inovance Technology Co. Ltd.
Suzhou Inovance Technology Co. Ltd.